



ESSENTIAL
FOR ENERGY
SAVINGS

Enjoy the benefits of softened water with Calmag's range of units

Energy essentials
providing savings with gas and electricity bills.

Limescale prevention
for showers, boilers, cylinders, washing machines, dishwashers & all other heating appliances.

Personal protection
for skin, clothes and hair.



CalSoft Mini >
12.5 litre vessel
1-8 people



CalSoft Midi >
18 litre vessel
1-11 people



CalSoft Maxi >
25 litre vessel
1-15 people

BUY WITH CONFIDENCE. PRODUCTS COME WITH A 5 YEAR PARTS GUARANTEE!



Contents	
Introduction	2 - 3
What is hard water?	4 - 5
How water softeners work	6 - 7
CalSoft Mini, Midi and Maxi	8 - 9
Quality assured	10 - 13
Choosing the right Calsoft Model for you	14
Supply and installation information	15
A typical installation	16 - 17
100% guaranteed build quality and fully tested	18-19
Some questions you may have	20 - 22
The complete range of Calmag products	23

Introduction

Calmag - the water treatment experts

At Calmag, our water treatment experts are specialists in the development and manufacture of the most **diverse range of water treatment solutions available in the UK.**

Founded in 2002, Calmag is the only independently owned UK manufacturer to produce a complete range of products and services to meet the needs of both domestic and commercial customers. Our continuous investment in stringent design, production and testing programmes are your assurance of great quality, reliable performance and best value, all backed by long Calmag guarantees, technical support and after-sales care.

Calmag domestic products offer the widest choice of home water solutions, to deliver the quality of water you want, with the added benefits of reduced energy usage and significant savings on household bills and maintenance costs.

Calmag commercial specialists design products to exact project specifications, resulting in **the most effective and efficient solutions** to meet heavy industrial demands.

Our work with industry partners and trade associations reflects our total commitment to supporting best practice and the continual development of water treatment excellence.

Professional installers have confidence in Calmag, with products that give **optimum performance combined with ease of installation.**

We hope that you find the information contained in this brochure will help you decide to use Calmag products and will give you years of excellent performance.

We're always here to help

If you have any queries or require advice on any of our products, please give us a call on our Helpline on 01535 210349 or visit www.calmagltd.com. **You can always rely on us for technical support and after-sales care.**

CHARLES WYSOCKI
MANAGING DIRECTOR
CALMAG



In Partnership with:



What is hard water?

The problems caused by limescale

One aspect of **water quality varies significantly** across the United Kingdom and that is water hardness.

Hard water contains dissolved minerals which are not present in soft water and it is these which give hard water its particular characteristics – scale and scum formation and **difficulty developing a soapy lather**. The minerals that contribute to water hardness are calcium and magnesium, mainly in combination with bicarbonate, sulphate and chloride.

Water is analysed by the water supply companies and the concentrations of all minerals present measured; the results of these measurements are available to all customers.

The feeling of washing and bathing in **soft, silky, scumfree water** is indeed luxurious, and softened water protects the bathroom and sanitaryware from ugly stains and scale associated with hard water. Domestic water softeners play an important role in today's modern home, along with other traditional 'white goods'.

The problems from hard water in your home

The calcium in hard water reacts with soaps and detergents making it difficult to develop a good soapy lather and producing a scum either on the surface of the water or round basins and baths. When hard water is heated above 61°C (or as it evaporates) the balance between the dissolved minerals are upset and the bicarbonate converts into carbonate. This leads to the precipitation of calcium carbonate scale, commonly called limescale.

Hard water causes two major problems for the domestic consumer:

- 1 Hard scale formation in the hot and cold water systems, this reduces efficiency of boilers and appliances which heat water, and causes unsightly deposits on taps and sanitaryware.**
- 2 Scum formation and increased use of soap, along with a difficulty in producing an acceptable lather with soaps and detergents.**



Limescale

Just 1.6mm of scale in heating systems **causes a 12% loss in heat transfer** from the energy source (gas, electricity) to water. In areas with a hard water supply, scale gradually builds up in boilers and on heating coils in hot water tanks. This causes the heaters and boilers to use more gas or electricity.

Hard scale also gradually builds up in hot water pipes and reduces the flow of water. This makes pumps work harder and can ultimately block the pipe. It will shorten the life of showers (heaters and shower heads), washing machines and water heaters, particularly immersion heaters, reducing their efficiency and **increasing maintenance and repair costs**.

Scum and lather: hard water increases the amount of soap, shampoos and detergents used, especially the amounts needed to produce an acceptable lather. The use of soaps, etc in hard water leads to the formation of an unpleasant scum on the water or as a soft deposit remaining as a watermark on basins and baths.

Ask for Calmag by name at your local Plumbers' Merchant
Contact us on **01535 210320** or visit **www.calmagltd.com**

Just one eighth of
an inch of limescale
**reduces heating
efficiency by 25%**

The Benefits of Calmag Water Softeners

- ✓ Compact and easy to install
under kitchen sinks
- ✓ Low volume of cleansing water
– less than conventional softeners
- ✓ Regular cleansing cycle will keep
the resin in prime condition
- ✓ Low salt consumption - saltsaver can
use any type of salt; block or tablet.
- ✓ Little programming required -
no flashing lights or confusing digits
- ✓ Low salt consumption
- ✓ Commissioning service available
- ✓ Suitable for installation
in garages, cupboards
and loft space

Do you live in a hard water area?

Take a look at the map and see if you live in a hard water area.

- **SOFT TO SLIGHTLY HARD**
0-100 MG/L AS CALCIUM CARBONATE (OR PPM)
- **SLIGHTLY HARD TO MODERATELY HARD**
100-200 MG/L AS CALCIUM CARBONATE (OR PPM)
- **HARD TO VERY HARD**
ABOVE 200 MG/L AS CALCIUM CARBONATE (OR PPM)

PPM = PARTS PER MILLION (1PPM = 1MG/L)



How water softeners work

Simply explained, here's how water softeners operate.

- ONE -

Hard water passes through a control unit into the resin vessel.

- TWO -

Calcium and Magnesium, constituents of water hardness, are attached to the Sodium saturated resin beads, usually sulphonated polystyrene.

- THREE -

This simultaneously releases Sodium ions and water hardness is eliminated. The process is called ion exchange.

- FOUR -

When the resin becomes saturated with Calcium and Magnesium it is recharged by passing a salt solution through the resin.

Hard water containing Calcium and Magnesium

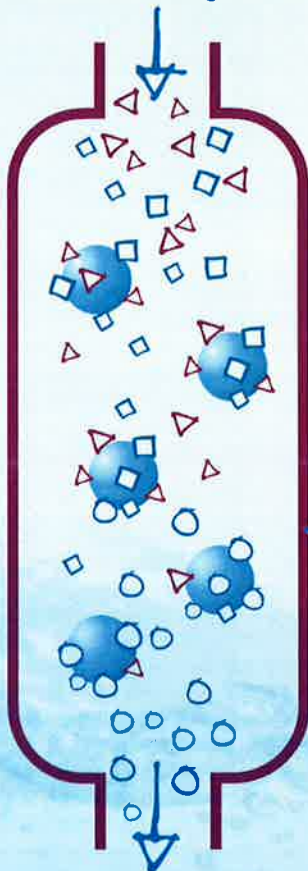



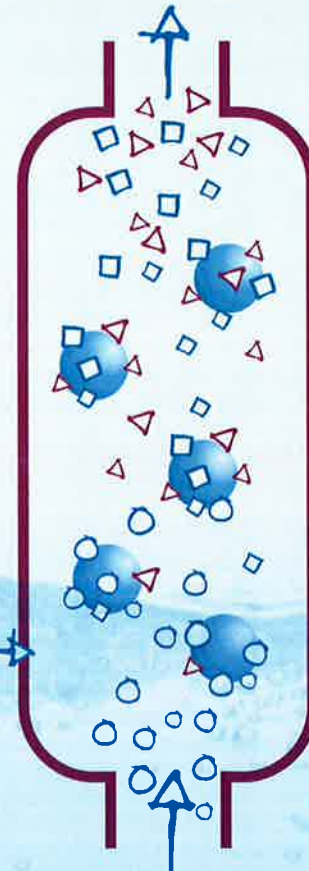

Softened water containing Sodium

Waste water containing Calcium and Magnesium



Brine solution containing Sodium

KEY

-  Ion Exchange Resin
-  Magnesium ions
-  Calcium ions
-  Sodium ions

 Ion Exchange Resin with Sodium attached.

 Ion Exchange Resin with Calcium and Magnesium attached.

It is estimated that an ion-exchange water softener could **save** in the region of **£200 for an average 4-person household** in a hard water area

Softened water not only **saves you money**, it makes life so much more pleasant. The feeling of washing and bathing in soft, silky, scum-free water is indeed luxurious, and **softened water protects** the bathroom and sanitaryware from ugly stains and scale associated with hard water.

Here are just some of the benefits of softened water:

- ✓ Softened water provides **real cost savings** in service, maintenance and replacement of water heaters, dishwashers, washing machines and showers and also extends their life
- ✓ Softened water improves the efficiency of hot water and heating systems - just 1.6mm (1/16") of scale build-up in heating systems will cause a **12% loss in heating efficiency**
- ✓ Softened water can **save some 50% of washing powder** and toilet soap consumption and similarly reduce the amount of shampoos, conditioners and cleaning products used
- ✓ Softened water **can help certain dry skin conditions** such as eczema



- ✓ Softened water **saves time** - independent studies have confirmed that considerable cleaning time is saved with softened water
- ✓ Softened water can, in time, **remove existing scale deposits** in hot water and heating systems as well as scale around taps and stains in baths and basins
- ✓ Softened water has a **clean silky feeling**. It makes bathtime a luxury without the need for bath oils or bubble bath liquids
- ✓ Softened water **makes hair soft** and easy to manage
- ✓ Softened water rinses completely away **without leaving scum**, even after shaving
- ✓ Softened water makes laundry brighter and glasses and **dishes sparkle and shine**
- ✓ Softened water makes washing the car easier and will **reduce streaking and spotting**.



EXTENDS THE LIFE OF DISHWASHERS



CAN HELP DRY SKIN CONDITIONS



REDUCES STREAKING



WATER HAS A CLEAN, SILKY FEELING

CalSoft Mini, Midi and Maxi Metered water softeners

The CalSoft range of water softeners have been **specifically designed** with the UK's increasing family homes in mind.

The energy saving units are suitable for all types of plumbing systems. Less salt and water are used as the metered, automatic unit only regenerates when necessary. Easy to operate electronics require little programming - simply adjust the water hardness level if needed. This compact, durable water softener also features a stylish cabinet and hood produces an endless supply of silky soft water, whilst maintaining optimum energy efficiency.

The most advanced domestic water softeners available, offering you some very specific advantages which include:

- ✓ Fully automatic and metered – only regenerates when required
- ✓ Low salt consumption
- ✓ Low water usage
- ✓ Designed to use the exact amount of salt
- ✓ No complicated programming required
- ✓ Compact
- ✓ High flow rate capabilities
- ✓ Suitable for all types of plumbing systems
- ✓ Can use tablet or block salt
- ✓ Ergonomically designed cabinet and hood
- ✓ Delayed regeneration
- ✓ Stores data in the event of a power cut
- ✓ Learns and remembers your water usage – saves on salt and water
- ✓ Uses food grade monospheric high capacity resin – unique
- ✓ Proportional brining only regenerates the resin that has been used
- ✓ 5 year parts guarantee and 12 months labour guarantee
- ✓ National distribution network through plumbers merchants
- ✓ Removes existing scale.

Ask for Calmag by name at your local Plumbers' Merchant
Contact us on **01535 210320** or visit **www.calmagltd.com**

Using a water softener **reduces the cost** of gas, and electricity bills

Units manufactured for all family sizes...

5 YEAR PARTS GUARANTEE



CalSoft Mini
1-8 people



CalSoft Midi
1-11 people



CalSoft Maxi
1-15 people



CALSLIM C KIT



CALFRESH CR KIT

Add a Calmag water filter for drinking water

Contaminants are trapped within the filter cartridge, therefore you need to change them on a regular basis to maintain a clean water supply. The lifespan of a cartridge is dependant on the quality of water passing through it and we recommend changing filter cartridges every 4-6 months.

See page 15

Quality assured

Getting under the skin

It's what's inside a water softener that's important. All Calmag softeners are made to the highest industry specifications and manufacturing standards, conforming to all the relevant regulations and BS guidelines. That's why, unlike some products that may cost a few pounds less, we can give a full 5 year parts guarantee on our water softeners.

Unique features designed with the installer in mind.

SMART VALVE

- Top of the range valve
- Calculates usage and saves on water and salt.
- Fully programmable.
- Delayed regenerative facility
- Suitable for all types of plumbing systems
- Suitable for all domestic situations
- Full flow inlet and outlet
- ¾" inlet/outlet capability
- High flow capacity. 70 litres per minute
- Stores data in case of power cuts
- **Learns usage - saves water and salt**
- Unique horizontal valve body, slim design and pressurised structure space saving
- 12v safety voltage, stable and extremely quiet
- Metered measurement but with a manual regeneration function included
- LCD display, user friendly, easy to operate and highly reliable
- Regeneration mode options: meter delay, meter immediate, timer and mix regeneration. Duration at each regeneration cycle can be adjusted to suit.

5 YEAR
PARTS
GUARANTEE



Thread inlet manufactured from 30% glass filled PP providing higher strength temperature and pressure limits



RESIN VESSEL

- 250,000 cycle test from 0-150psi pressure
- High quality fibreglass reinforced vessel made by a complete seamless moulding process
- Conforms to BS4994
- Tested to pressures of 10 bar (150psi)
- HDPE liner to contribute to the mechanical strength
- Corrosive resistant and rustproof
- Tank designed to withstand the hydrostatic forces.
- Fibres are wound in a tangential direction for strength. **Becomes stronger than steel**
- NSF approved
- Burst test to FOUR times its operating pressure (600psi)

RESIN

- High purity premium grade resin bead
- Gel polystyrene sulfonate cation exchange resin
- Designed expressly for the treatment of potable water
- **Exceeds** the relevant EEC requirements
- High bead integrity
- Excellent chemical and physical stability
- Very low extractables



Quality assured

Getting under the skin



QUICK CONNECT BYPASS

- Our quick connect bypass included on all 3 models are designed for **ULTIMATE** convenience and saving on installation time.



- Quick release fittings to adapt to $\frac{3}{4}$ " or 1" inlet and outlet
- Integrated meter in bypass saving 5 inches of space

BRINE TUBE

- **High quality** brine pick up tube
- Manufactured to ensure correct amount of brine pick up.
- Slotted holes to ensure no salt encrustations
- Fits neatly behind the vessel to ensure no damage from salt.

MAIN CABINET

- No sharp edges/weak points
- High quality tough unique designed cabinets
- Uses PP material for durability and strength. **5 year guarantee**
- Colour does not fade by UV
- Curved to ensure no salt build up in cabinet corners
- UV and chemical resistant
- High degree of flexibility
- Puncture resistant
- Ability to elongate under stress, without cracking or tearing
- Outstanding resistance to low temperatures

QUALITY ASSURED AND TESTED



5 YEAR PARTS GUARANTEE

Ask for Calmag by name at your local Plumbers' Merchant
Contact us on **01535 210320** or visit **www.calmagltd.com**

Choosing the right CalSoft model for you

The chart below will give you an indication of which CalSoft water softener will be best for your home. If you need any more information, you can consult your plumber or installer or **call us on 01535 210320**.

	CALSOFT MINI	CALSOFT MIDI	CALSOFT MAXI
Fits under a sink	YES	NO	NO
Parts guarantee	5yr	5yr	5yr
Metered	YES	YES	YES
No of people	1-8	1-11	1-15
Capacity per regeneration @300ppm	2000 litres	3000 litres	4000 litres
All domestic situations	YES	YES	YES
Salt used per regen (approx)	2kg	2.8kg	3.5kg
Water used per regen (approx)	85 litres	115 litres	202 litres
Preferred salt used	Tablet	Tablet	Tablet
Installation kit included	YES	YES	YES
Water hardness test kit included	YES	YES	YES
Extended warranty available	YES	YES	YES
Max flow rate l/min with 15mm kit	50	50	50
Max flow rate l/min with 22mm kit	70	70	70
Max pressure recommended	5 bar	5 bar	5 bar
Salt storage capacity	15kg	25kg	35kg
Inlet/Outlet	3/4" BSP or 1" BSP	3/4" BSP or 1" BSP	3/4" BSP or 1" BSP

Drinking Water

Supply & installation information

Advice from various international bodies state that when a water softener has been installed then a separate **unsoftened water tap should be provided** - mainly for drinking water purposes.

This would normally be at the kitchen sink as this would ordinarily be the main area that people would pour drinking water from and also used for cooking purposes. Alternative positions for this supply, or more than one supply can be installed, and is purely down to the individual application. The separate unsoftened drinking tap should then be connected into the supply pipe prior to the bypass valve and then run directly to the specified drinking tap. See illustrations below.

The Regulations state that "All premises supplied with water for domestic purposes shall have at least one tap conveniently situated for the drawing of drinking water". Drinking water must also comply with the Regulations which stipulate a maximum limit of 200ppm for sodium. The Department of Health recommends that this sodium level should not be exceeded for baby food preparation and also for individuals that may be on a low sodium diet.

As the maximum limit is set at 200ppm, it is therefore necessary to check if this would be exceeded in the area and could be the case where the water is extremely hard. This level of sodium would be exceeded if the incoming water hardness reaches 425ppm (assuming that the incoming level of sodium is zero from the mains supply).

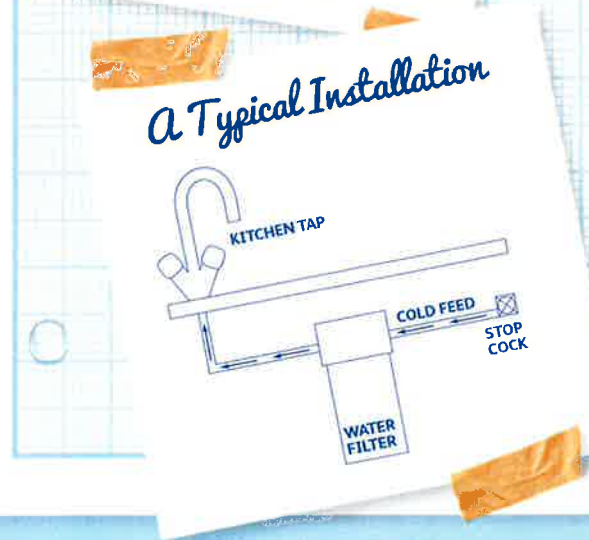
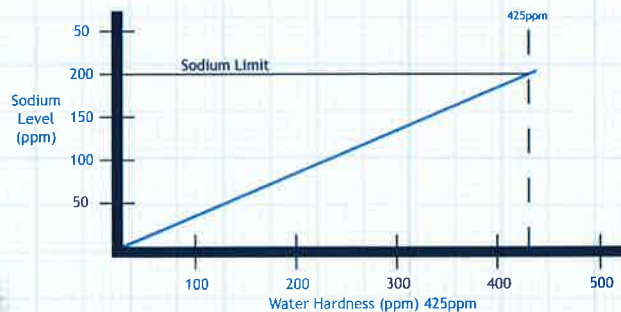
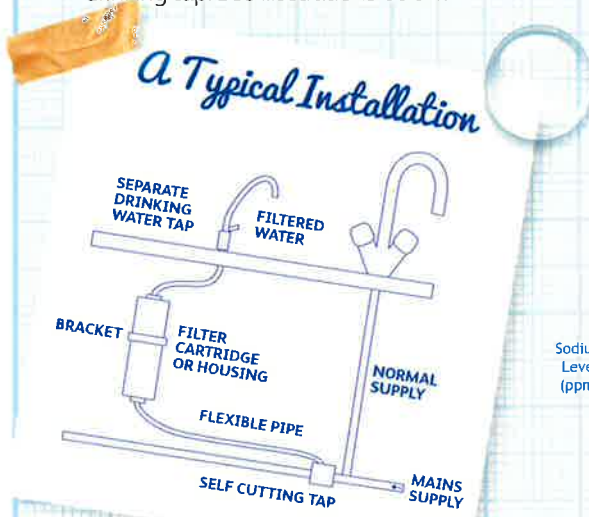

The above can be checked with the **Calmag water hardness test kit** or alternatively asking the local water supplier the level of hardness and sodium the area.



A typical installation

Installing CalSoft in your home

The **CalSoft Metered water softeners** have been specifically designed with the UK's increasing family homes in mind.

With an increasing number of new homes being plumbed in 22mm or with combination boilers, then **it is essential** that the home owner is not caught out by purchasing the incorrect water softener.

This is why we have developed a product that is suitable for both **15mm and 22mm installations** – the only difference is the actual installation kit.

The unit is compact and has been designed to fit **underneath a single kitchen cupboard** if required and comes with its own salt bucket to ensure that salt encrustations do not develop around the mechanics of the unit – this is one area that is often overlooked with other units.

The CalSoft metered is extremely water efficient and does work on a joint regeneration and cleansing cycle which not only recharges the resin bed but cleanses it from sediment contamination & chlorine particles. The CalSoft metered also has the added benefit of a greater salt saving mechanism.

The electronics are **easy to operate** but we have ensured that with the factory settings then it is not necessary for any adjustments when initially installed and the only adjustment that may be required is to set the water hardness level – an operation that takes a maximum of 30 seconds.

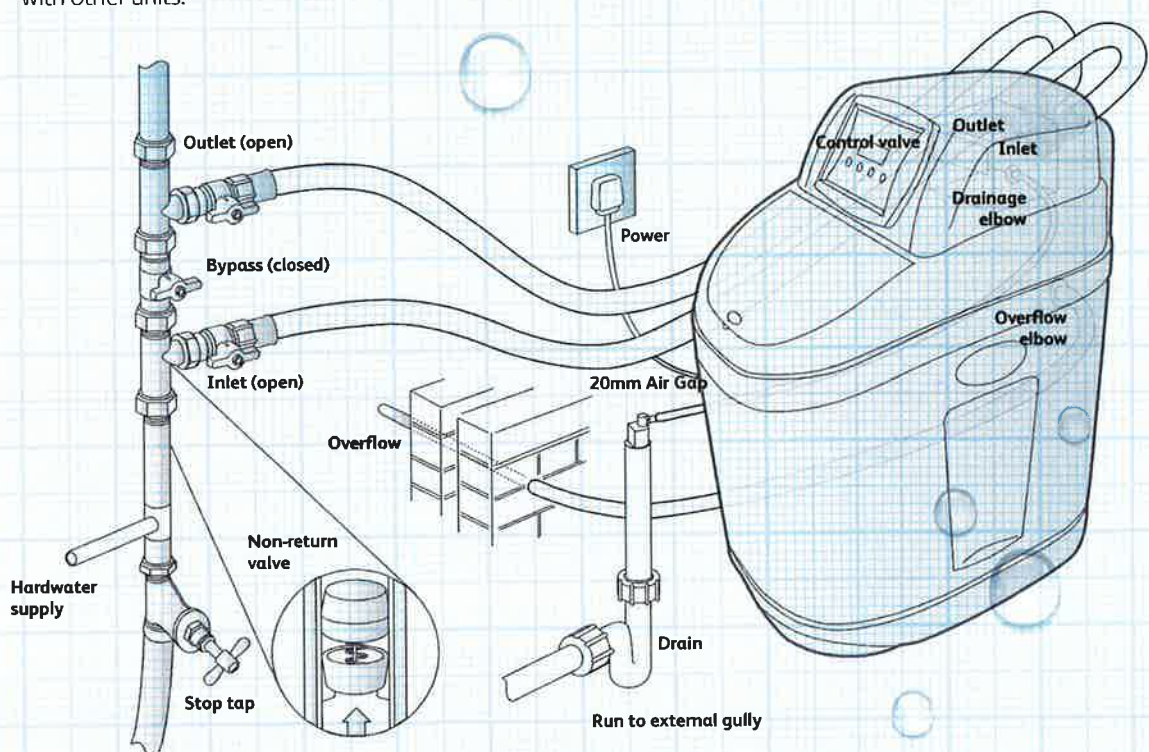

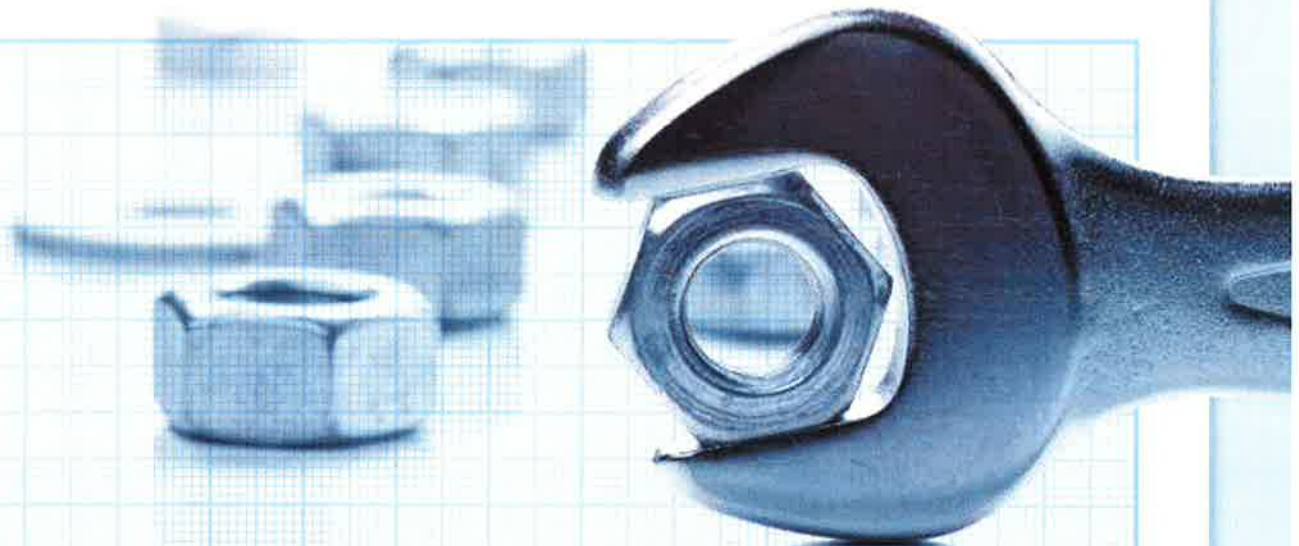

Dimensions

	CALSOFT MINI	CALSOFT MIDI	CALSOFT MAXI
A	470mm	470mm	470mm
B	660mm	900mm	1100mm
C	330mm	330mm	330mm

Please note these dimensions are approximations and should be checked depending where the installation will be carried out i.e. in a confined area. Dimensions do not include pipework dimensions

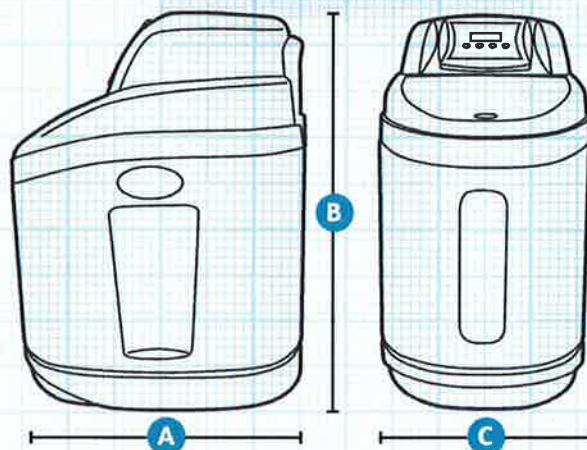

Installation kits

The standard 1/2"/15mm installation kits are suitable for homes with a cold water storage tank. If however, your home has a combination boiler or direct hot water system we recommend the installation of our high flow 3/4"/22mm installation kit.

Each kit comes with inlet valve, outlet valve, bypass valve, washers and 2 x stainless steel hoses. We use stainless steel full bore hoses for maximum flow rates.



1/2" / 15MM KIT



3/4" / 22MM KIT

Ask for Calmag by name at your local Plumbers' Merchant
 Contact us on **01535 210320** or visit **www.calmagltd.com**

100% guaranteed build quality and fully tested

We are **committed** to ensuring that our customers always get the best water quality so we ensure that our products function at their optimum level at all times. Because they are built to the **highest standards** and rigorously tested before they leave the factory, we offer comprehensive customer support and a **5 year guarantee**.

Quality build program

Before our products are despatched they are built under strict conditions to ensure all parts are fitted and working correctly. This build includes:

- ✓ Resin and vessel build
- ✓ Valve build
- ✓ Unit assembled
- ✓ Packed and ready for despatch



Tested at every stage

Once built and prior to despatch we subject each unit to an extensive testing program to ensure they are functioning at peak performance. This includes:

- ✓ Valve testing
- ✓ Program settings checked
- ✓ Cycle testing - 250,000 times
- ✓ Pressure testing - FOUR times burst pressure



Guarantee and technical backup

Once despatched our service doesn't stop there. Simply register your unit by post or online at www.calmagltd.com and you'll receive:

- ✓ 5 years parts guarantee. Extended labour warranty also available
- ✓ Technical Support Team are available to assist in any troubleshooting areas and to give correct impartial advice. We ensure that customers receive a high level of service before and after purchase



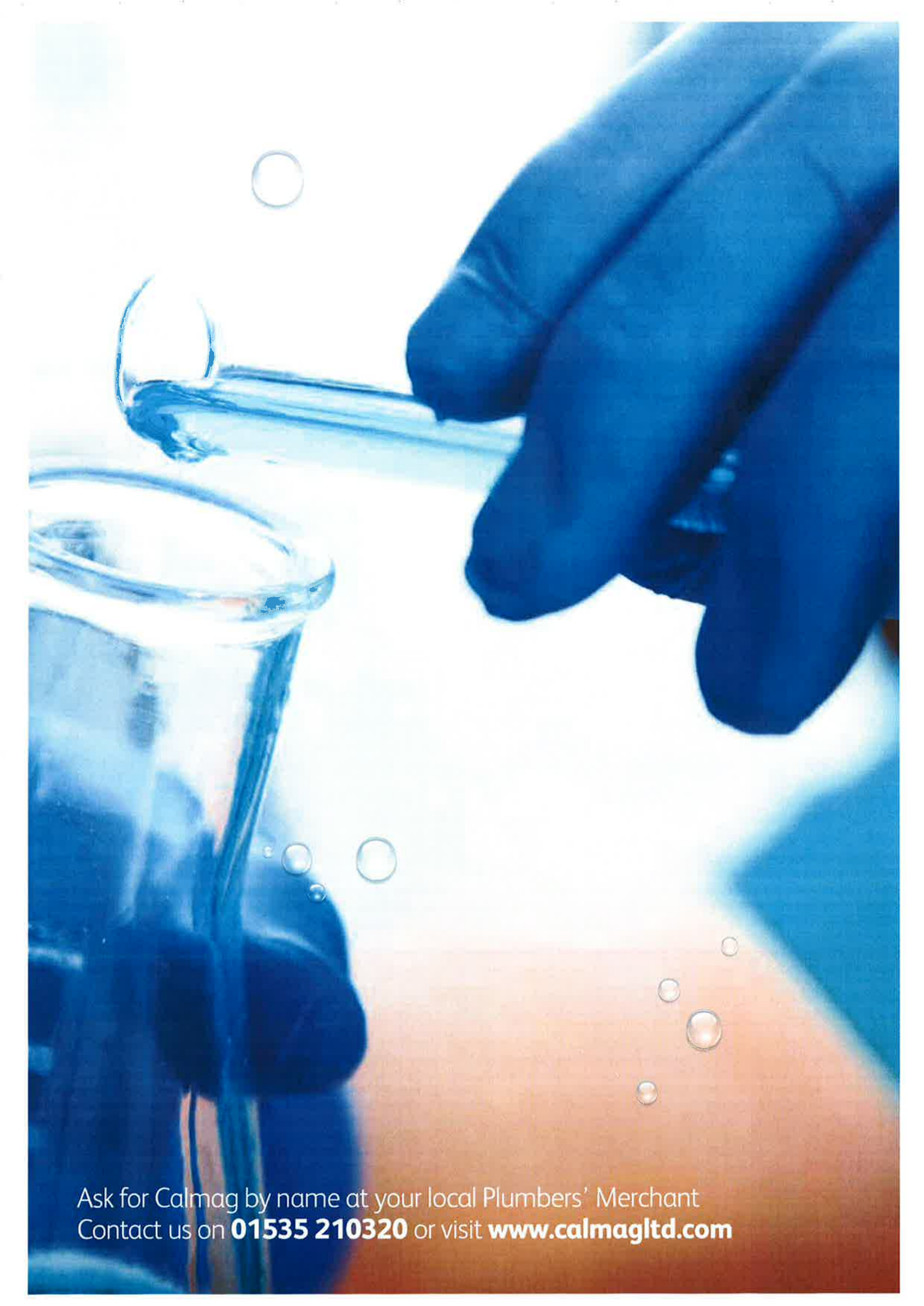

Ask for Calmag by name at your local Plumbers' Merchant
Contact us on **01535 210320** or visit **www.calmagltd.com**

Some questions you may have

Here are the answers to some of the commonest questions that we are asked about water softeners. If you have a specific query that isn't covered here, **please call us on 01535 210320.**

Softened water around the home

Softened water has benefits all around the home. Whether it's for drinking, cooking, washing or laundry, **it can save you money** and protect your water systems and appliances.

Q How much does a water softener cost?

A The cost will vary according to the type and size. Unlike other home improvements the savings provided by a water softener can produce a payback within 2-4 years.

Q How can I justify the investment?

A Most people who have used a water softener would simply say that to wash and bathe in clear, scum free water is sufficient justification. However, use of softened water can give significant savings which include many long-term benefits such as the protection of bathroom equipment, all water-using appliances and a reduction of water heating bills. Substantial savings can also be made on soap products, cleaning materials and especially cleaning times.

Q Can a water softener be moved and relocated?

A **Definitely yes.** It is as easy as removing a washing machine or dishwasher and can be moved from home to home. In many cases, a water softener has been known to help sell a property as a result of its protection of the hot water system and bathroom sanitaryware.

Q What about servicing and maintenance?

A A water softener is constantly in operation but because there are few moving components, its life is much longer than most other domestic appliances.

Q Can softened water be used in an aquarium?

A Softened water may be acceptable. If in doubt, check with your local aquatic supplier.

Q Can softened water be used in car batteries and steam irons?

A **No.** Only distilled or de-ionised waters should be used in car batteries. Many modern steam irons can use hard and/or softened water. The guidance given in the manufacturer's instructions should be followed.

Q Will my water bill be affected by fitting a water softener?

A A small amount of water will be used to regenerate the softener, but your water bill will not be affected unless you have a water meter fitted. However, this increased water use may be offset by using less softened water for cleaning.

9 grams of scale reduces boiler efficiency by **5.6%**. Fuel consumption and CO2 emissions increase by that amount.



Softened water and health

Water softening **removes the hardness minerals**, calcium and magnesium, by exchanging these minerals for sodium in common salt.

Q Should a water softener be installed to leave a drinking tap which supplies unsoftened water?

A Yes. Although there is no absolute legal requirement in the Water Supply (Water Fittings) Regulations, 1999, the British Water Code of Practice recommends that a mains water tap should be fitted, where reasonably practicable, when an ion-exchange water softener is installed. It is particularly important that all water mixed with powdered milk for babies' feed is drawn from an unsoftened mains tap. This is because powdered milk already contains sufficient sodium, and very young babies have a limited tolerance to sodium. Anyone on a sodium-restricted diet should follow their doctor's instructions.

Q Will those who prefer to drink softened water be deprived of minerals necessary for good health?

A The beneficial minerals necessary for good health come mostly from food in a balanced diet. Neither hard drinking water nor softened water can provide a significant proportion of the daily needs for minerals - for example a glass of hard water contains only about one tenth of the calcium that is in an equal volume of milk.

Q How much sodium is there in softened water?

A The average daily intake of sodium from food and water for an adult is 3.6g (equivalent to 9g of salt) but the Department of Health's recommended daily allowance (RDA) is 2.4g sodium (equivalent to 6g salt). Many natural and manufactured foods and drinks contain sodium and contribute to this total intake.

	Sodium	Equivalent Salt	%RDA
1 litre of milk	0.6g	1.5g	25%
1 litre of artificially softened water in a hard water area (300mg/l as calcium carbonate equivalent)	0.14g	0.35g	6%

Ask for Calmag by name at your local Plumbers' Merchant
 Contact us on **01535 210320** or visit **www.calmagltd.com**

Some questions you may have

Installation of Water Softeners

It is important that water softeners are **correctly installed**, used and maintained according to manufacturer's instructions.

Q Is a water softener easy to install?

A **Usually.** Modern water softeners are small enough to fit easily into any kitchen or utility room and ideally near to the incoming mains water supply with access to a drain and electricity.

Q Do I need electricity?

A It depends on the type of water softener. Most softeners are fitted with a small electric system for automatic control. This ensures that the softener regenerates at the correct intervals and at the correct time. The automatic control consumes about the same amount of electricity as a kitchen clock. Some water softeners operate hydraulically using the water flow to control regeneration and do not require electricity.

Q Can water softeners be used with the direct high flow rate systems now being fitted in the UK?

A **Yes**, but seek advice from a specialist supplier to ensure a suitable high flow rate model is supplied and correctly installed.

Q Will installation of a water softener conform to the Water Fittings Regulations?

A Provided your supplier installs your softener in accordance with the current WRAS information and guidance note No 9-07-01 Information for installation of Ion Exchange Water Softeners for systems supplying water for domestic purposes.

Q Does a water softener need a specific water pressure?

A **No.** Water softeners work within a wide range of pressures, but a minimum pressure of 20 psi (1.4 bar) is required. If your water pressure is excessively high or low, this can be corrected at installation.

Q Can a water softener drain into a septic tank or package treatment plant?

A **Yes.** Regeneration waste from a water softener will have no adverse effect on a septic tank or package treatment plant, provided both are the right size for the maximum number of people in the house. Softened water can help reduce the amount of detergent discharged into the waste system.

Ask for Calmag by name, at your local Plumbers' Merchant
Contact us on **01535 210320** or visit **www.calmagltd.com**

The complete range of Calmag products

Calmag offer a vast range of commercial and domestic products for all your water treatment needs. For more information on any other of our products **call us on 01535 210320.**

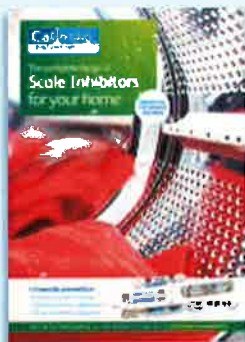

Scale Inhibitors



Water Softener



Ultra Violet



Heating Filter



Water Treatment Chemicals

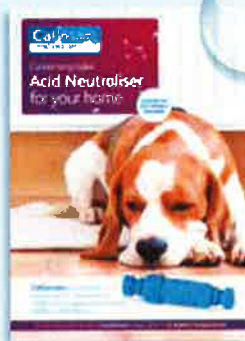

Acidic Neutraliser



Anti-freeze



Uni-dose



BuildCert Chemicals



Powerflushing



Electromag



Commercial Water Softeners



Commercial Ultra Violet

Guaranteed confidence in water quality

Calmag's **fresh, innovative approach** to water quality has led to the development of the most extensive and effective range of water treatment solutions within the UK water treatment industry – our products are designed with the **needs of our customers** in mind – the merchant, installer and consumer. Calmag's philosophy is based on providing products and services to meet the real needs of all our customers – we don't simply produce what we think you should buy - Calmag have the **unique design** and production capabilities to produce what you want - when you want it!

Beware of imitations!

There have been a number of instances when customers have been under the impression that they have bought a Calmag product but, in reality, have been supplied with an alternative and inferior product that fails to match the industry-leading performance and aesthetic appeal of ours. So we strongly advise customers to **ask for our product by name**. Other products may seem to offer similar qualities, but if it isn't Calmag, it simply won't perform to our standards.

There are **two key ways to check** that you've purchased a genuine Calmag product: they carry the **WRAS approval** on scale inhibitors, and **BuildCert** and **ESTr** approvals on a range of chemical inhibitors.

Calmag is a member of and in partnership with:



For more information regarding all Calmag products and services please go to www.calmagltd.com

Tel: 01535 210320 Fax: 01535 210321 Email: sales@calmagltd.com